

# ReletLS リレットLS

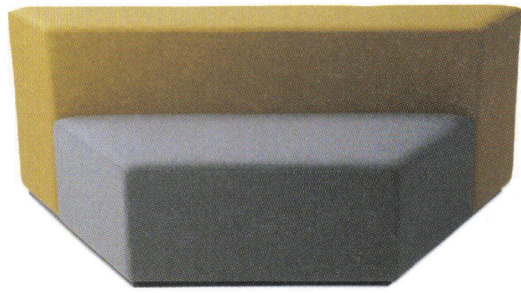

張地 背 プレイザー CUZ58(H)  
座 プレイザー CUZ1J(H)

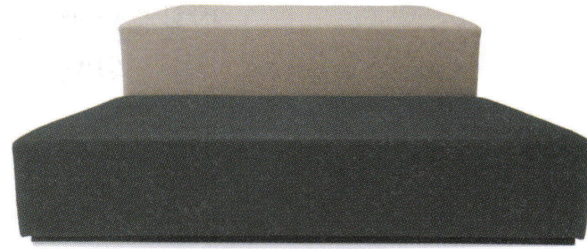

張地 背 プレイザー CUZ86(H)  
座 プレイザー CUZ30(H)

## ユニット

### 1850

S6016-4014

**Size** W1850×D910×H700(SH420)  
**Price** A = ¥193,000 E = ¥265,000  
B = ¥207,500 F = ¥293,500  
C = ¥222,000 G = ¥322,000  
D = ¥236,500

### 2070

S6016-4021

**Size** W2070×D910×H700(SH420)  
**Price** A = ¥203,000 E = ¥275,000  
B = ¥217,500 F = ¥303,500  
C = ¥232,000 G = ¥332,000  
D = ¥246,500

## Materials

台輪:メラミン化粧板(ブラック)



張地 プレイザー CUZ1J(H)



張地 プレイザー CUZ1J(H)

## ベンチ

### 1440

S6016-6014

**Size** W1440×D550×H420  
**Price** A = ¥80,000 E = ¥105,000  
B = ¥85,000 F = ¥115,000  
C = ¥90,000 G = ¥125,000  
D = ¥95,000

### 2070

S6016-6021

**Size** W2070×D550×H420  
**Price** A = ¥104,000 E = ¥139,500  
B = ¥111,000 F = ¥154,000  
C = ¥118,000 G = ¥168,500  
D = ¥125,000

## Materials

台輪:メラミン化粧板(ブラック)

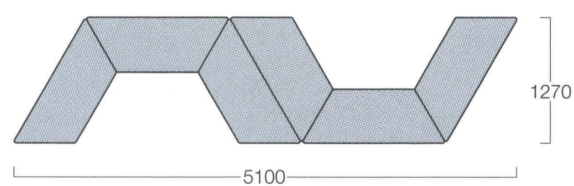

ベンチ1440×6

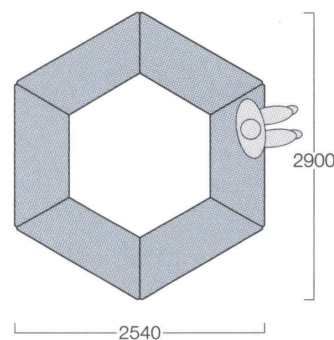

ベンチ1440×6

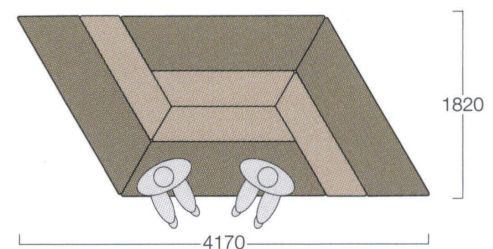

ユニット2070×4

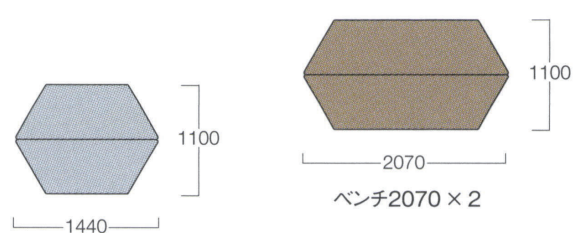

ベンチ1440×2

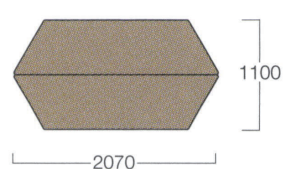

ベンチ2070×2

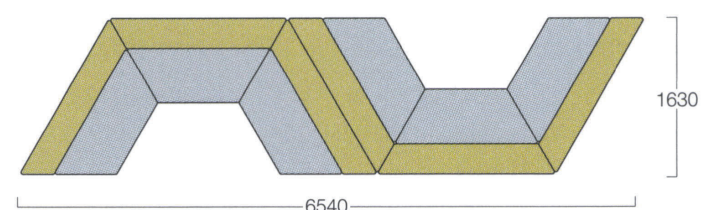

ユニット1850×6